

IC-500213 Dynamic Bollard

H:800 mm



Impact Control

IC-500213 Dynamic Bollard

H:800 mm

ENGINEERED FOR IMPACT CONTROL

The Dynamic Impact Bollard is developed to manage impact forces intelligently - protecting people, equipment, and infrastructure in demanding industrial environments.

FORCE MANAGEMENT, NOT JUST RESISTANCE

Rather than stopping impact abruptly, the system controls and redirects forces - reducing stress on anchors, floor slabs, and surrounding structures.

STRUCTURAL INTEGRITY FROM THE BASE UP

Engineered to work as a complete system - from foundation interface to upper structure - ensuring consistent performance under repeated impacts.

CONFIGURED FOR REAL OPERATIONS

Available in multiple height configurations to match varying traffic conditions, risk levels, and operational requirements.

CONTROLLED ANGULAR DEFLECTION

At impact, the base enables a controlled tilt of up to 10°, dissipating kinetic energy and limiting peak force on anchors and infrastructure.

ALL-ENVIRONMENT DURABILITY

Electro-galvanized steel with high-performance powder coating (RAL 1018), providing long-term resistance to corrosion, UV exposure, chemicals, and demanding industrial conditions - with minimal maintenance.

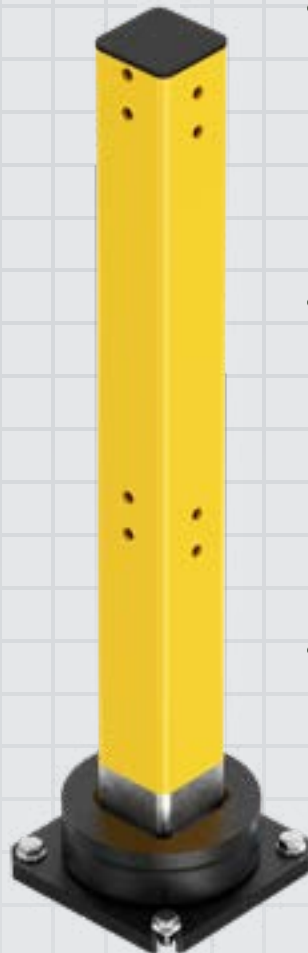

Impact Control

IC-500213 Product Specification and Use – H: 1000/800/600/400 mm



MATERIAL PROPERTIES

MATERIAL:	AISI 1020
YIELD STRENGTH:	3.51571e+08 N/m ²
TENSILE STRENGTH:	4.20507e+08 N/m ²



VOLUMETRIC PROPERTIES referring to Bollards only

MASS:	15.2 kg
-------	---------



COLOR & COATING



BOLLARD & BRACKET

RAL1018. Electro-Galvanized + powder coating. According to ISO9001:2015, certified by SGS.



BASE

Base: RAL 9005



RAIL

Grey. Hot dip galvanized steel. Heavy duty structural finish.



DIMENSIONS

Height (H):	800 mm	Guard Rail (Standard):	80×40×2.9mm
Bollard Profile:	80×80×5 mm	Guard Rail (HD):	80×80×2.9mm
Base:	195×195×72 mm		



IMPACT RATING referring to Bollards only

2,200J



TEMPERATURE RATING & INSTALLATION

TEMPERATURE RATING

-40 to +65° C

INSTALLATIONS

On top of solid concrete surfaces only

ELASTOMER MATERIAL

NR (Natural Rubber)
SVR 3L



Anchor screws: 14×135 concrete screws

Impact Control

IC-500213 Product Specification and Use – H: 1000/800/600/400 mm



PRODUCT SPECIFICATIONS

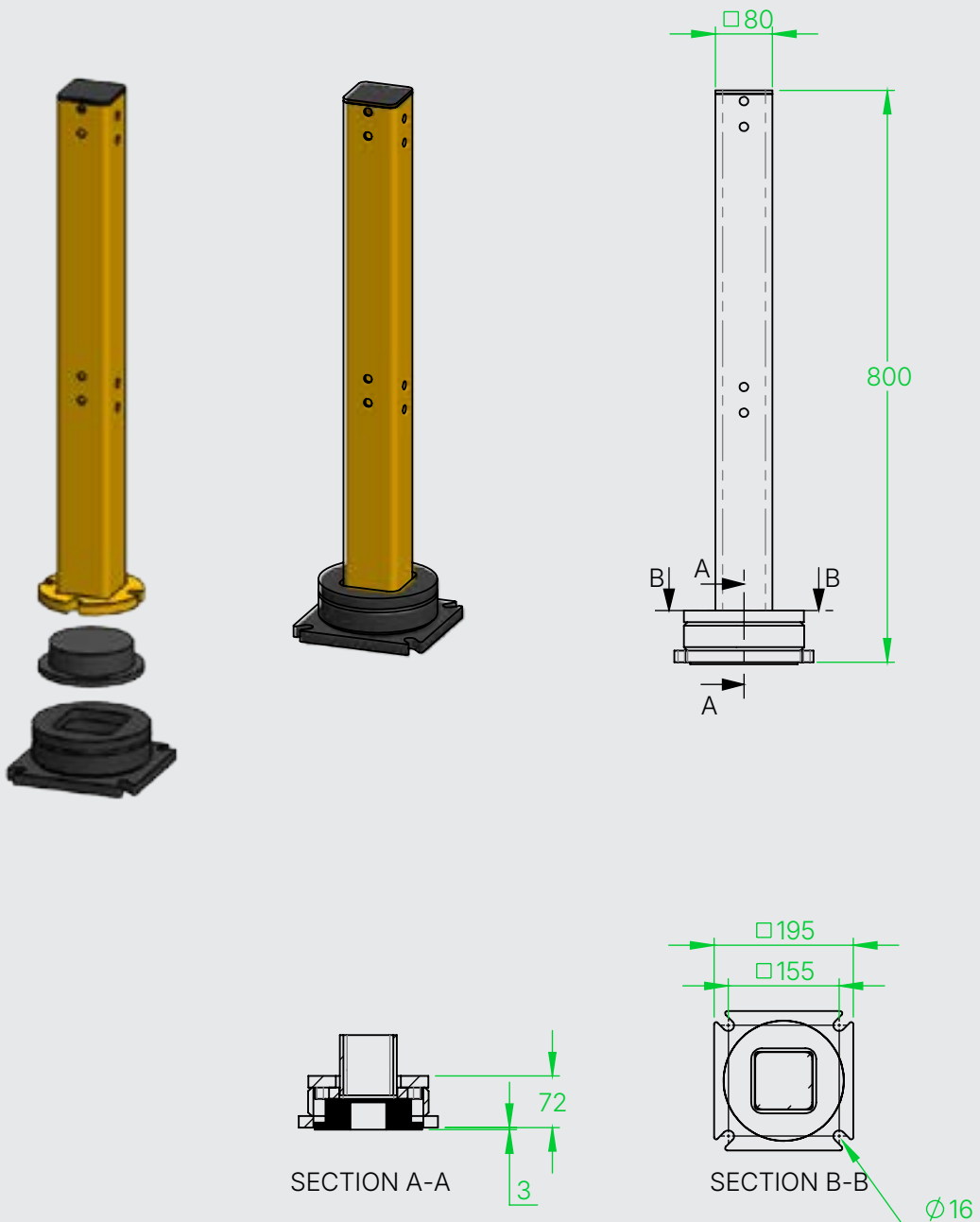

Impact Control



IMPACT TEST RESULTS

800 mm Bollard
Impact Height: 400mm Estimated Energy Absorption: 2,200J

